

Übersicht Bahnsteighalle: BA12-BA18 K1-K20 R1-R10 B1 u. B2

BA12			BA13		B14		BA15		BA16			BA17		BA18				
K9 26.10.2019	D 5	R6 15.2.2020	Kran	K13 19.6.2021	D 7	R8	D 9	K17	D 10	R10 26.5.2021	D 1	K1 20.10.2018	Kran	K5 5.9.2020	D 3	R4 3.3.2021	D 4	B2
K10 9.3.2019		K12 30.5.2020		K14 14.12.2019		K16		K18 27.6.2020		K20 18.11.2020		K2 16.4.2019		K4 1.2.2020		K6 27.2.2021		K8 2.5.2020
R5 30.10.2020		K11 16.12.2020		R7		K15		R9		K19 17.4.2021		R1 30.6.2018		K3 7.9.2019		R3 11.7.2020		

Insgesamt fertig: 16 Kelchstützen, 22 Kelchfüße, 7 Restkelche, ein Brillenwandkelch und 2 Schwindgassen

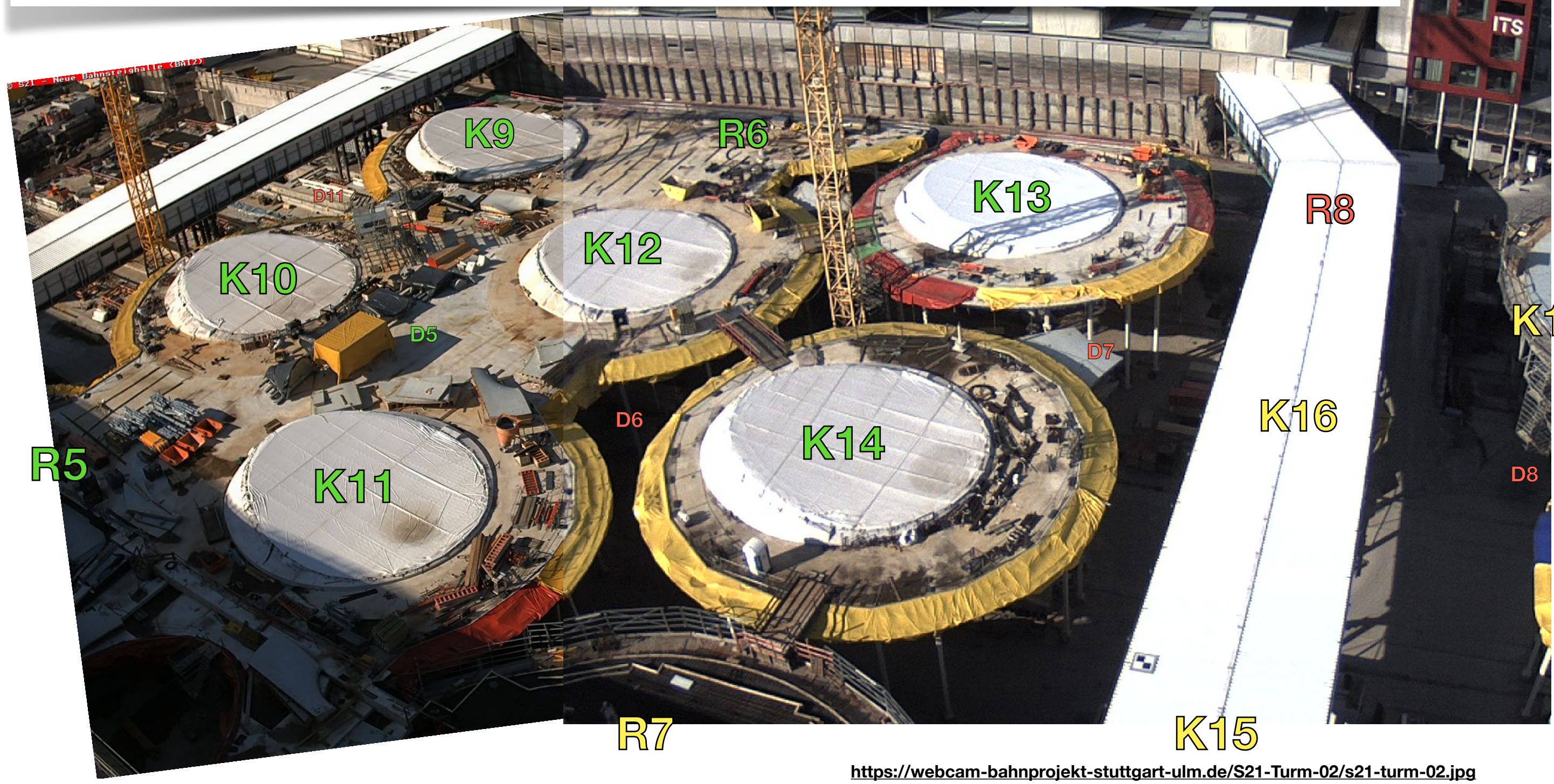

<https://webcam-bahnprojekt-stuttgart-uhl.de/S21-Turm-02/s21-turm-02.jpg>

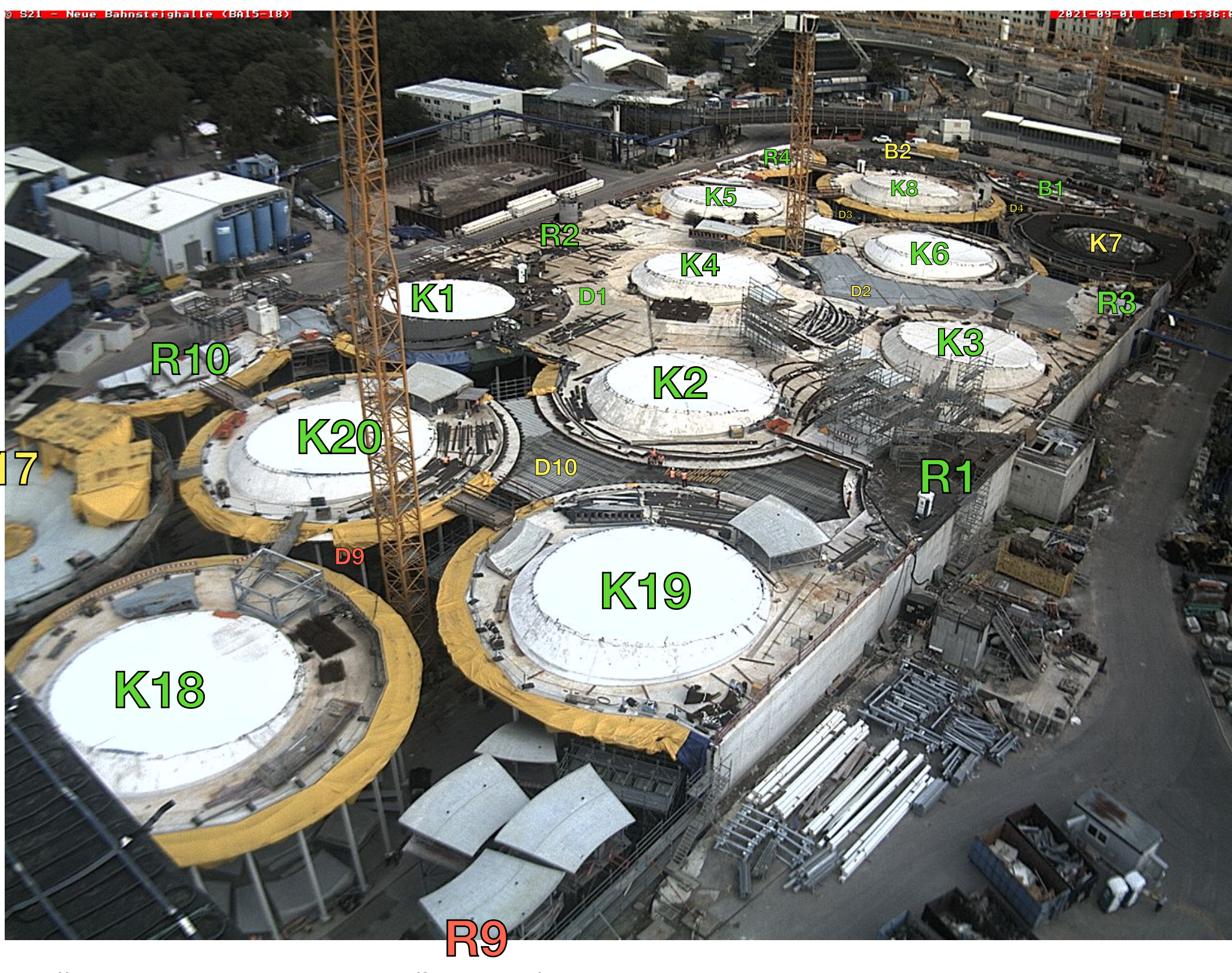

<https://webcam-bahnprojekt-stuttgart-uhl.de/S21-Turm-01/s21-turm-01.jpg>

<https://webcam-bahnprojekt-stuttgart-uhl.de/S21-Turm-03/s21-turm-03.jpg>

BA: Bauabschnitt; K: Kelchstütze; R: Restkelch; B: Brillenwandkelch; D: Dach-Schwindgasse 1. September 2021



Übersicht Bahnsteighalle: BA9-BA11 K21-K28 R11-R14 B3 u. B4

Insgesamt fertig: 16 Kelchstützen, 22 Kelchfüße, 7 Restkelche, ein Brillenwandkelch und 2 Schwindgassen

BA11:														
Gleis:		8		7	6		5	4		3	2		1	
Bahnsteig:					Spannbetonbrücken									
BA10:														



<https://webcam-bahnprojekt-stuttgart-ulm.de/S21-Bahndirektion-Sued/S21-Bundesbahndirektion-Sued.jpg>

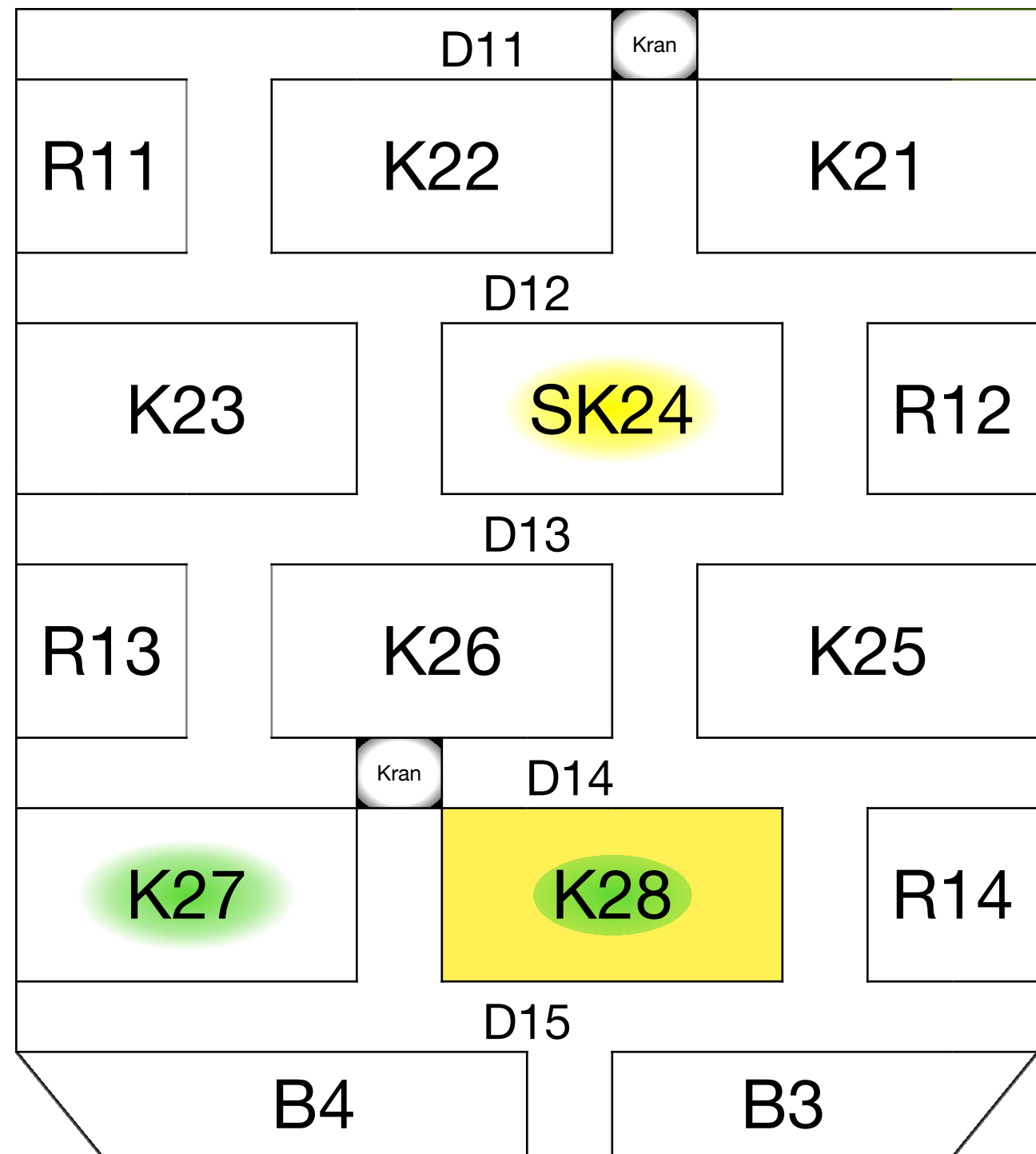

BA: Bauabschnitt; K: Kelchstütze; R: Restkelch; B: Brillenwandkelch

BA 10 und 11:
Grün: Bahnsteigkante
Blau: Fahrbahnen

1. September 2021



Beschriftung durch S21Bau.TV

1. September 2021

 **Rot: nicht begonnen**

 **Gelb: wird gebaut**

 **Grün: ist betoniert**

✓ Gebaut:

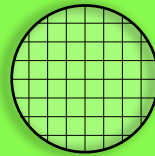
- ➔ 16 Kelchstützen
- ➔ 0 Glasgitter auf den Lichtaugen 
- ➔ 7 Restkelche
- ➔ 1 Brillenwandkelch
- ➔ 22 Kelchfüße
- ➔ 11 Galeriestützen
- ➔ 2,8 Schwindgassen (D2 Kranaussparung)
- ➔ 3 Lounge-Deckenplattenabschnitte
- ➔ 0 Lounge-Oberlichter

...muss noch:

davon im Bau:

- 12 K7, K17 und K28
- 28 R7
- 7 B2
- 6 SK24
- 5 D10 und D4
- 6 bei R7
- 8 bei R5

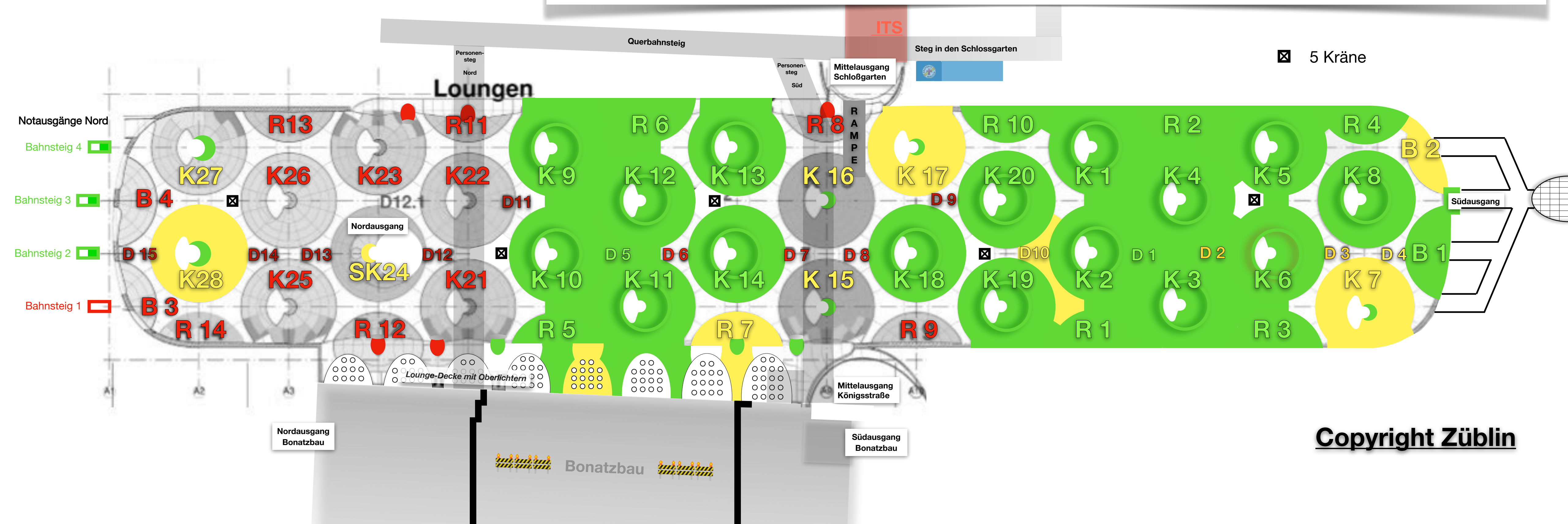



Stadtbahntunnel





















































BA22 ✓

⚠️ BA21 ⚠️

BA19/20 ✓



Betonage der Kelche und Schwindgassen

	Kelchblüte		Kelchfuß	Hutze		Restkelch		Schwindgasse	
1	K1	20. Oktober 2018	 10.06.2017	 28.11.2018		1 R1	30. Juni 2018	1 D1	20. Januar 2021
2	K10	9. März 2019	 19.04.2018	 03.04.2019		2 R2	8. Dezember 2018	2 D2	1.9.2021 bis auf die Kranaussparung
3	K2	16. April 2019	 03.08.2017	 22.05.2019		3 R6	15. Februar 2020	3 D5	29. Juni 2021
4	K3	7. September 2019	 20.12.2017	 02.10.2019		4 R3	11. Juli 2020	4 D10	
5	K9	26. Oktober 2019	 15.05.2018	 20.11.2019		5 R5	30. Oktober 2020	5 D4	
6	K14	14. Dezember 2019	 12.11.2018	 03.02.2020		6 R4	3. März 2021	6 D3	
7	K4	1. Februar 2020	 10.10.2017	 07.03.2020		7 R10	26. Mai 2021	7	
8	K8	2. Mai 2020	 16.12.2019	 03.06.2020		8 R7		8	
9	K12	30. Mai 2020	 05.11.2019	 08.07.2020		9 R9		9	
10	K18	27. Juni 2020	 13.02.2020	 11.08.2020		10		10	
11	K5	5. September 2020	 01.03.2019	 15.10.2020		11		11	
12	K20	18. November 2020	 09.07.2020	 05.12.2020		12		12	
13	K11	16. Dezember 2020	 03.06.2020	 29.01.2021		13		13	
14	K6	Bergfest 27. Februar 2021	 12.04.2019	 30.03.2021		14 R8		14	
15	K19	17. April 2021	 27.08.2020	 12.05.2021				15	
16	K13	19. Juni 2021	 15.12.2018	 16.07.2021					
17	K7		 05.12.2020						
18	K17		 17.05.2020						
19	K28		 08.06.2021						
20	K27		 29.04.2021			1 B1	29. Juli 2021		
21	SK24					2 B2			
22	K21					3 B3			
23	K22					4 B4			
24	K23								
25	K25								
26	K26								
27	K15		 09.05.2019						
28	K16		 05.06.2019						

Das Datum kann bei alten Daten einige Tage versetzt sein.

1. September 2021





Nordkopf: Bauabschnitt 1-8:1. September 2021 

✓	BA 1	Rohbau Schwallbauwerk Nord ✓
✓	BA 2	
✓	BA 3	
✓	BA 4-7	...sind die neuen SSB Stadtbahntunnel für die U5-U7 und U12.
✓	BA 8	Wiederherstellung der Rampe für den Kehrtunnel Heilbronner Straße und Freilegung der Notausgänge Nord.

Bahnsteighalle: Bauabschnitt 9-18:

	BA 9	Letzter Abschnitt der Seitenwand ist gebaut.
	BA 10	Bodenplatte und Seitenwand auf Seite Bonatzbau ist gebaut. Die Baulogistik-Rampe ist nun abgetragen. Zugang über Rampe in BA14 und Gleis 2 und 3 in BA11
	BA 11	liegt über der S-Bahn und wird mit Spannbetonbrücken überspannt.
✓	BA 12	
	BA 13	
	BA 14	Baulogistik Rampe ist auf der fertigen Bodenplatte angelegt.
	BA 15	
✓	BA 16	
	BA 17	
	BA 18	Brillenwandkelch B1 zum Anschluß an Südkopf ist fertig. B2 wird gebaut.

Südkopf: Bauabschnitt 19-25:

✓	BA 19/20	Südausgang und Notausgänge auf BA19 müssen noch gebaut werden.
	BA 21	
✓	BA 22	...liegt unter den Zugangstunneln der neuen Stadtbahnhaltestelle Staatsgalerie und ist komplett fertig.
	BA 23	...ist die alte Haltestelle Staatsgalerie mit ihren Zugangstunneln. Diese sind nun abgebrochen. 
✓	BA 24	Schwallbauwerk Süd wird gebaut.
✓	BA 25	